

Hollow plunger cylinders *Application & selection*

Shown: HCS-20, RWH-121, RWH-202

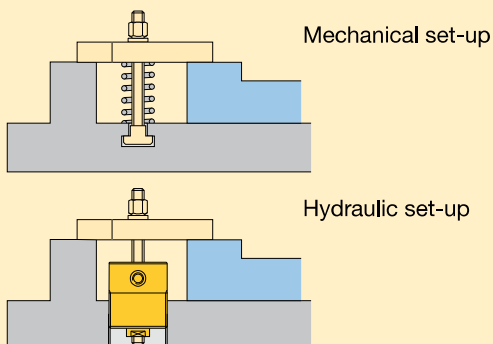

▶ These cylinders are regularly used for upgrading mechanical clamping to faster and easier hydraulic clamping. Other typical applications include production pressing, punching and crimping operations.



Traditional mechanical elements in a clamping fixture are replaced by a hollow plunger hydraulic cylinder.

■ Two Enerpac RWH-121 hollow cylinders mounted at the back side of a fixture.

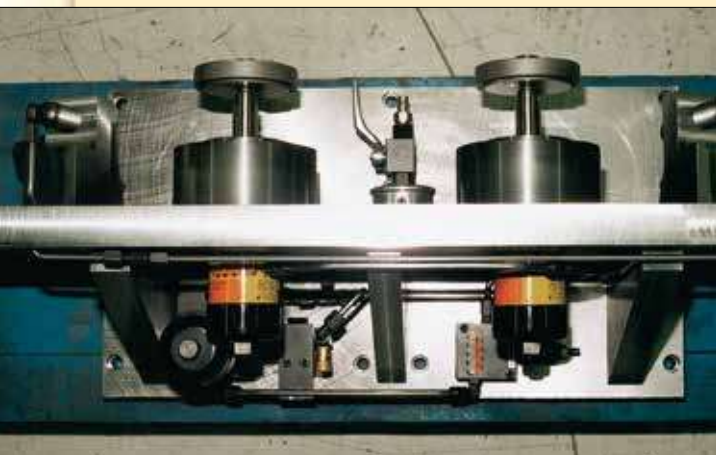

For high force push and pull applications on and around the fixture

- Load can be attached to either end of the cylinder, providing a choice of push or pull actions - both realizing full cylinder capacity
- Very high cylinder capacities contained within small dimensions allow compact fixture designs
- Spring return operation allows for easy unloading of the workpiece
- Threaded collars and base mounting holes allow mounting flexibility, including table-top surfaces and T-slots
- Nickel-plated plungers, plunger wipers and internal venting prevent corrosion and support longer operation life on all HCS models
- The CY series hollow plunger cylinders can be manifold mounted (except for CY-1254-25).

Product selection

Cylinder capacity ¹⁾	Stroke	Center hole diameter	Model number	Effective area	Oil capacity	Operating pressure
kN	mm	mm		cm ²	cm ³	bar
11,6	6,4	9,9	CY1254-25	5,61	3,61	210
17,8	8,4	13,5	MRH-20	8,58	6,72	210
17,8	8,4	13,5	RWH-20	8,58	6,72	210
17,8	8,4	13,5	RWH-20T	8,58	6,72	210
21,5	10,2	10,7	HCS-20*	6,19	6,23	350
33,0	7,9	19,6	CY2129-25	15,94	12,62	210
33,0	16,0	19,6	CY2129-5	15,94	25,56	210
56,3	12,1	13,0	HCS-50*	16,26	19,50	350
59,3	16,0	22,6	CY2754-5	28,65	45,88	210
61,4	8,1	19,6	MRH-120	17,81	14,09	350
61,4	8,1	19,6	QDH-120	17,81	14,09	350
61,4	8,1	19,6	RWH-120	17,81	14,09	350
61,4	25,9	19,6	RWH-121	17,81	45,23	350
83,7	14,2	17,0	HCS-80*	23,42	32,61	350
104,6	13,2	26,9	RWH-200	30,58	38,84	350
104,6	51,3	26,9	RWH-202	30,58	155,35	350
113,4	16,0	21,0	HCS-110*	32,65	52,27	350
160,2	12,7	33,3	RWH-300	46,58	58,99	350
160,2	25,4	33,3	RWH-301	46,58	118,31	350
160,2	63,2	33,3	RWH-302	46,58	294,97	350

¹⁾ At maximum operating pressure. **Note:** Seal material Buna-N, Polyurethane, Teflon.

* This product is made to order. Please contact Enerpac for delivery information before specifying in your design.

Optional Heat Treated Hollow Saddles

Saddle type	Cylinder model number	Saddle model No.	Saddle Dimensions (mm)		
			A	B	C
Threaded hollow	RWH-200, 202	HP-2015	53,6	1"-8	9,7
	RWH-300, 301, 302	HP-3015	63,3	1¼"-7	9,7

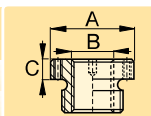

Smooth hollow saddles are standard on all RWH-20 and 30-models (RWH-12 models are not equipped with saddles).

MRH-20, 120

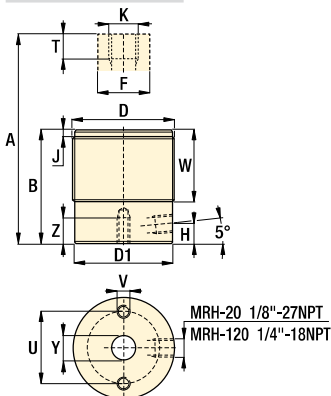

RWH-20, 120, 121, QDH-20

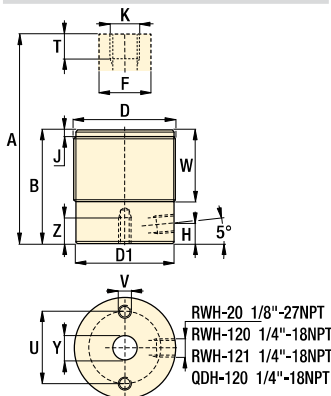

other RWH model

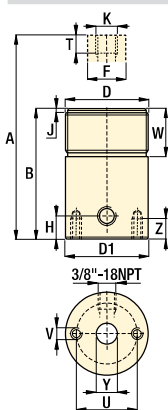

CY models

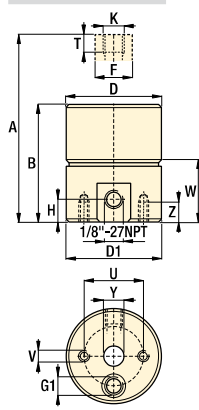

HCS models

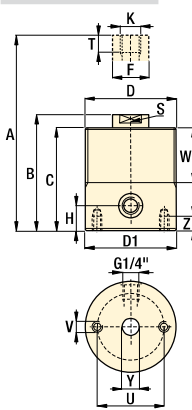

Force: 11,6 - 160,2 kN

Stroke: 6,4 - 63,2 mm

Pressure: 55 - 350 bar

- E** Cilindros de émbolo hueco
- F** Vérins a piston creux
- D** Hohlkolbenzylinder

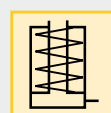

Options

Flange nuts

86 ▶

Important

Use Grade 8 (DIN12.9) bolt quality or better for pulling. Use Grade B7 (DIN10.9) threaded rod quality or better for pulling applications.

RWH cylinders can be used up to 700 bar maximum working pressure (except RWH-20 and RWH120).

Product dimensions in mm []

Model nr.	A	B	C	D	D1	F	H	J	K	S	T	U	V	W	Y	Z	kg
				ø	ø							ø					
CY1254-25	57,2	50,8	-	ø 44,5	44,5	14,2	7,4	-	.375-16 UNC	-	15,7	31,8	.250-20 UNC	24,6	ø 9,9	9,7	0,5
MRH-20	60,8	52,3	-	M48 x 1,5	45,0	25,3	7,1	3,0	ø 13,5	-	22,4	35,1	M6 x 1	38,1	ø 12,7	6,4	0,6
RWH-20	60,7	52,3	-	1.875-16 UN	45,5	25,4	7,1	3,0	ø 13,5	-	22,1	35,1	.250-20 UNC	38,1	.500-20 UNF	6,35	1,4
RWH-20T	60,7	52,3	-	1.875-16 UN	45,5	25,4	7,1	3,0	.500-20 UNF	-	12,4	35,1	.250-20 UNC	38,1	ø 13,5	6,4	1,4
HCS-20*	84,3	74,4	66,0	M58 x 1,5	58,0	18,0	11,0	-	M10 x 1,5	14,0	25,8	40,0	M6 x 1	40,0	ø 10,7	10,0	1,1
CY2129-25¹⁾	58,7	50,8	-	ø 66,8	63,5	28,7	7,9	-	.750-10 UNC	-	28,7	44,5	.375-16 UNC	20,3	ø 19,6	8,6	1,1
CY2129-5¹⁾	85,3	69,3	-	ø 66,8	63,5	28,7	7,9	-	.750-10 UNC	-	28,7	44,5	.375-16 UNC	39,1	ø 19,6	11,2	1,4
HCS-50*	96,5	84,4	75,0	M65 x 1,5	65,0	28,0	14,0	-	M12 x 1,75	22,0	24,2	45,0	M8 x 1,25	45,0	ø 13,0	12,0	1,5
CY2754-5¹⁾	92,2	76,2	-	ø 88,9	79,5	31,8	11,2	-	.875-9 UNC	-	31,8	53,8	.375-16 UNC	40,9	ø 22,6	11,2	2,7
MRH-120	64,5	56,0	-	M70 x 1,5	70,0	35,0	10,0	4,8	M18 x 1,5	-	15,2	50,0	M8 x 1,25	30,2	ø 17,3	6,1	1,4
QDH-120	64,5	56,4	-	2.750-16 UN	69,9	35,1	9,9	4,8	.750-10 UNC	-	15,7	50,8	.312-18 UNC	30,2	ø 17,3	6,4	1,4
RWH-120	64,5	56,4	-	2.750-16 UN	69,9	35,1	9,9	4,8	.750-16 UNF	-	15,5	50,8	.312-18 UNC	30,2	ø 17,3	6,4	1,4
RWH-121	107,7	81,8	-	2.750-16 UN	69,9	35,1	13,5	4,8	.750-16 UNF	-	18,5	50,8	.312-18 UNC	30,2	ø 17,3	6,4	2,2
HCS-80*	109,4	95,2	85,0	M75 x 1,5	75,0	32,0	17,0	-	M16 x 2	24,0	32,2	55,0	M8 x 1,25	50,0	ø 17,0	12,0	2,3
RWH-200	136,9	124,0	-	3.875-12 UN	98,6	53,8	19,1	4,8	1.562-16 UN	-	22,4	82,6	.375-16 UNC	38,1	ø 26,9	9,7	6,2
RWH-202	213,1	161,8	-	3.875-12 UN	98,6	53,8	19,1	4,8	1.562-16 UN	-	22,4	82,6	.375-16 UNC	38,1	ø 26,9	9,7	7,7
HCS-110*	120,4	104,4	93,0	M90 x 2	90,0	40,0	19,0	-	M20 x 2,5	32,0	36,7	65,0	M10 x 1,5	60,0	ø 21,0	15,0	3,6
RWH-300	140,2	127,5	-	4.500-12 UN	114,0	64,5	21,6	4,8	1.812-16 UN	-	22,4	91,9	.375-16 UNC	42,2	ø 33,3	15,7	8,6
RWH-301	165,6	140,2	-	4.500-12 UN	114,0	64,5	21,6	4,8	1.812-16 UN	-	22,4	91,9	.375-16 UNC	42,2	ø 33,3	15,7	9,8
RWH-302	241,8	178,6	-	4.500-12 UN	114,0	64,5	21,6	4,8	1.812-16 UN	-	22,4	91,9	.375-16 UNC	42,2	ø 33,3	15,7	10,9

¹⁾ For these models G1 = manifold and 1/8-27 NPTF

Linear Cylinders
Power Sources
Valves
Pallet Components
System Components
Yellow Pages