

Enerpac hydraulic cylinders are available in hundreds of different configurations. Whatever the industrial application... lifting, pushing, pulling, bending, holding... whatever the force capacity, stroke length, or size restrictions... single- or double-acting, solid or hollow plunger, you can be sure that Enerpac has the cylinder to suit your high force application. Enerpac jacking cylinders fully comply to ASME B30.1 (except BRD-Series).



With the 3rd Generation comes a trio of key features

The next evolution of the legendary Enerpac RC-Series hydraulic cylinder. The driving force of the Enerpac cylinder range, the new **RC-TRIO** is as **versatile** as ever. Featuring a new Trio Bearing System for **enhanced durability** and a hybrid spring-return system for **faster retraction** and even **greater productivity**.

System for **enhanced durability** and a hybrid spring-return system for **faster retraction** and even **greater productivity**.

NEW RC-TRIO SERIES CYLINDERS

New TRIO Bearing System

- Includes up to 4 high-performance wear bands that offer increased resistance to damage, reducing bearing load and increasing cylinder lifespan.
- Hardened composite material wear bands increase bearing surface area for greater sideload resistance - Significantly improving cylinder life.
- New high-performance Polyethylene seals last longer than ever, improving lifespan and keep you working for longer.

New TRIO Stop Ring

- Part of the Trio Bearing System, the Trio Stop Ring includes an additional wear band or high-strength bronze to absorb greater side load
- Capable of taking full cylinder extension force
- Features durable wiper to help prevent contamination from entering the cylinder during retract cycles.

New TRIO Spring System

- Hybrid pre-tensioned return springs for up to 3x faster retraction and increased productivity.
- High-strength steel wire improves spring life
- Spring retention design improves serviceability while allowing higher pre-load during assembly
- Spring is easily removed without special tools.

Durable Piston Rod

- High-strength steel plunger for improved life and sideload resistance
- Nickel-plated plunger coating improves corrosion protection
- Internal plunger threads for easy tool fixturing.

Enhanced Ergonomics

- Standard carry handles on cylinders from 15 up to 25 kg. Sizes above include certified lifting eyes or optional handles.
- Collar threads, plunger threads and base mounting holes enable easy fixturing (on most models).



Improved Saddle Retention

- Hardened plunger saddle protects plunger end during all lifting operations
- Easily removable for access to plunger mounting threads
- Tilt and smooth saddles available as accessories (compatible with new range of CATS-Series Tilt Saddles).





































Enduring Compatibility

- For full compatibility and peace of mind, the new RC-Series model numbers, external dimensions and threads remain unchanged from prior RC-Series cylinders. Ensuring compatibility with historical versions and systems.

Note: The cut-away drawing is representative of typical cylinder construction, and may not represent all cylinders in this section.



Hydraulic Cylinders and Lifting Products Section Overview

Capacity ¹⁾ ton (kN)	Stroke Range (mm)	Cylinder Type and Functions	Series	Page
5 - 95 (45 - 933)	16 - 362	General Purpose Cylinders, Single-Acting Accessories: Saddles, Base Plates, Mounting Blocks, Clevis Eyes	 RC A, CATS JBI, RE	 6 ▶ 10 ▶
10 - 150 (63 - 1589)	50 - 250	Aluminium Cylinders, Single-Acting, Lock Nut, Hollow Plunger	  RAC RACL RACH	 12 ▶ 14 ▶ 16 ▶
20 - 150 (229 - 1589)	50 - 250	Aluminium Cylinders, Double-Acting, Solid Plunger	 RAR	 18 ▶
4 - 74 (43 - 727)	17 - 600	Multi-Stage Telescopic Cylinders, Low-Height Telescopic Cylinders	 RT RLT	 20 ▶ 22 ▶
5 - 150 (45 - 1386)	6 - 62	Flat Jack Cylinders, Single-Acting Low-Height Cylinders, Single-Acting	 RSM RCS	 24 ▶
10 - 1000 (97 - 10.165)	6 - 17	Ultra-Flat Cylinders, Single-Acting, Load Return with Stop Ring or Tilting Function	 CULP CUSP	 26 ▶ 27 ▶
60 - 500 (606 - 5114)	45 - 50	Low Height Lock Nut Cylinders Single-Acting, Load Return	 LPL	 28 ▶
2,5 - 50 (24 - 506)	127 - 154	Pull Cylinders, Single-Acting, Spring Return	 BRC BRP	 30 ▶
12 - 145 (125 - 1429)	8 - 258	Hollow Plunger Cylinders, Single- and Double-Acting	  RCH RRH	 32 ▶ 34 ▶
4 - 23 (35 - 222)	28 - 260	Precision Production Cylinders, Double-Acting (including Mounting Attachments)	 BRD	 36 ▶
10 - 520 (101 - 5108)	16 - 1219	Long Stroke Cylinders, Double-Acting	 RR	 38 ▶
50 - 1000 (550 - 10.644)	50 - 300	High Tonnage Cylinders, Single- and Double-Acting	  HCG HCR	 46 ▶ 50 ▶
50 - 1000 (550 - 10.644)	50 - 300	High Tonnage Lock Nut Cylinders, Single- and Double-Acting	  HCL HCRL	 54 ▶ 58 ▶
1 - 95 (8,9 - 933)	11 - 362	Cylinder - Pump Sets, Single-Acting Extreme Environment Products Power Box, Portable Tool Sets	 SC RC, P, V SL, SR, SW	 60 ▶ 62 ▶ 63 ▶
2 - 100 (20 - 980)	62 - 460	Aluminium and Steel Jacks Industrial Steel Bottle Jacks	 JH, JHA GBJ	 64 ▶ 65 ▶
54 - 181 (533 - 1778)	356 - 686	POW'R RISER® Mobile Lifting Jacks POW'R LOCK® Mobile Lift System	 PR PL	 66 ▶ 68 ▶

¹⁾ All ton values specified in this catalog are metric ton and are for cylinder class identification only. Please refer to the kN data for calculations.

▼ From left to right: RC2510, RC53, RC1002, RC108, RC5010, RC156



- Trio Bearing system with hardened composite wear bands for optimal side load resistance
- Strengthened Trio Stop Ring improves durability and side load resistance
- Trio Hybrid pre-tensioned spring system provides faster retraction
- High-grade polyethylene seals for low wear and long service life
- Plunger wiper reduces contamination, extending cylinder life.
- Collar and plunger threads and base mounting holes enable easy fixturing (on most models)
- Standard certified lifting eyes on cylinder models above 25 kg weight. Interchangeable with optional CHM6 carrying handle
- Designed for use in all positions
- Baked enamel finish for increased corrosion resistance
- Includes CR400 coupler, dust cap and collar thread protector
- RC-Series model numbers, external dimensions and threads remain unchanged from prior RC-Series cylinders

▼ *Foundation repair: to re-stabilize the foundation, the 308 ton silo needed to be lifted, levelled and structurally supported. 25 ton RC-Series hydraulic jacks were attached to a bracket on the top of each steel pier. Powered by a Z-Class pump, the hydraulic jacks applied 20 ton of force at each placement to lift the silo 5,1 cm.*



The Industry Standard General Purpose Cylinder



Saddles

All RC cylinders (except RC50 and RC101) have a hardened removable grooved saddle. For tilt and flat saddles, see the RC-Series accessory page. All CATS-Series Tilt Saddles use a nitrocarburization surface treatment for improved corrosion protection.

Page: 10



Base Plates

To ensure the stability of cylinders for lifting applications, base plates are available for 10, 25 and 50 ton RC cylinders.

Page: 10



Specialty Attachments

For solving all kinds of application problems, specialty attachments are available for 5, 10 and 25 ton RC cylinders.

Page: 172

▼ *Synchronous lifting set-up for 200 ton petrochemical process module using twelve RC2510 cylinders. To ensure the stability of the cylinders JBI25 base plates are installed.*



Single-Acting, General Purpose Cylinders



Optional Carrying Handle CHM6

Standard certified lifting eyes on cylinder models above 25 kg weight (RC5010 and heavier models). Interchangeable with optional carrying handle. Order model number **CHM6**.

▼ **QUICK SELECTION CHART** For complete technical information see next page.

Cylinder Capacity	Stroke	Model Number	Cylinder Effective Area	Oil Capacity	Collapsed Height	
ton (kN)	(mm)		(cm ²)	(cm ³)	(mm)	(kg)
5 (45)	16	RC50	6,4	10	41	1,0
	25	RC51	6,4	16	110	1,0
	79	RC53	6,4	50	165	1,5
	127	RC55 *	6,4	83	216	1,9
	177	RC57	6,4	115	273	2,4
	232	RC59	6,4	151	324	2,8
10 (101)	26	RC101	14,4	38	90	1,8
	54	RC102 *	14,4	78	121	2,3
	105	RC104	14,4	152	171	3,3
	156	RC106 *	14,4	226	248	4,4
	203	RC108	14,4	294	298	5,4
	257	RC1010 *	14,4	373	349	6,4
	304	RC1012	14,4	441	400	6,8
	356	RC1014	14,4	516	451	8,2
15 (142)	25	RC151	20,3	51	124	3,3
	51	RC152	20,3	104	149	4,1
	101	RC154 *	20,3	205	200	5,0
	152	RC156 *	20,3	308	271	6,8
	203	RC158	20,3	411	322	8,2
	254	RC1510	20,3	516	373	9,5
	305	RC1512	20,3	619	424	10,9
	356	RC1514	20,3	723	475	11,8
25 (232)	26	RC251	33,3	86	140	5,9
	50	RC252 *	33,3	166	165	6,4
	102	RC254 *	33,3	339	216	8,2
	158	RC256 *	33,3	525	273	10,0
	210	RC258	33,3	697	324	12,2
	261	RC2510	33,3	867	375	14,1
	311	RC2512	33,3	1033	425	16,3
	362	RC2514 *	33,3	1202	476	17,7
30 (295)	209	RC308	42,9	880	387	18,1
50 (498)	51	RC502	71,3	362	176	15,0
	101	RC504	71,3	719	227	19,1
	159	RC506 *	71,3	1131	283	23,1
	260	RC5010	71,3	1855	384	31,8
	337	RC5013	71,3	2399	460	37,6
75 (718)	156	RC756	102,6	1601	286	29,5
	333	RC7513	102,6	3417	492	59,0
95 (933)	50	RC1002	133,1	676	219	36,7
	168	RC1006	133,1	2239	357	59,0
	260	RC10010	133,1	3466	449	72,6

* Available as set, see note on this page.

RC-Trio Series



Capacity:
5 - 95 ton

Stroke:
16 - 362 mm

Maximum Operating Pressure:
700 bar



Think Safety

Manufacturer's rating of load and stroke are maximum safe limits. Good practice encourages using only 80% of these ratings.

Page: **312**



Lightweight Aluminium Cylinders

If you need a higher cylinder capacity-to-weight-ratio the **RAC-Series** are the perfect choice.

Page: **13**



Gauges

Minimize the risk of overloading and ensure long, dependable service from your equipment. Refer to the System Components

Section for a full range of gauges.

Page: **127**

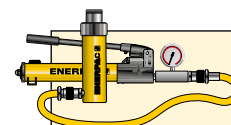

Cylinder-Pump Sets

All cylinders marked with an * are available as **sets** (cylinder, gauge, couplers, hose and pump) for your ordering convenience.

Page: **60**

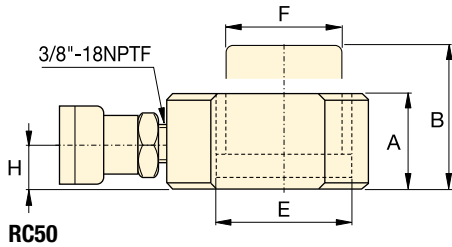
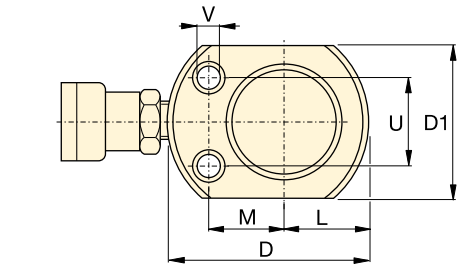

RC50

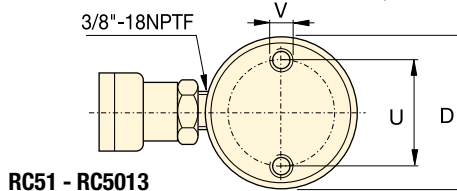
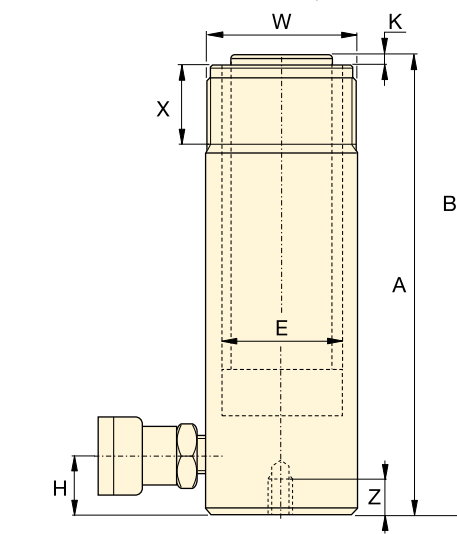
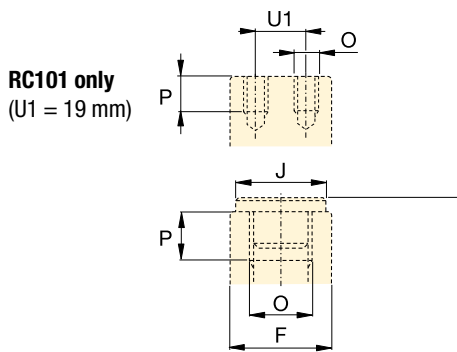

RC51 - RC5013

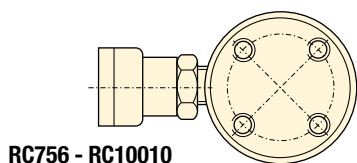

RC756 - RC10010



Speed Chart and Pump Selection Tool

See the Enerpac Cylinder Speed Chart in our 'Yellow Pages' to determine your approximate cylinder speed. See Pump Selection Tool on website for help to choose the most suitable pump for your application.

Page: **321**

◀ For full features see previous page.

Cylinder Capacity	Stroke	Model Number	Cylinder Effective Area	Oil Capacity	Collapsed Height	Extended Height	Outside Dia.
ton (kN)	(mm)		(cm ²)	(cm ³)	A (mm)	B (mm)	D (mm)
5 (45)	16	RC50 ²⁾	6,4	10	41	57	58 ³⁾
	25	RC51	6,4	16	110	135	38
	79	RC53	6,4	50	165	244	38
	127	RC55 ¹⁾	6,4	83	216	343	38
	177	RC57	6,4	115	273	450	38
	232	RC59	6,4	151	324	556	38
10 (101)	26	RC101 ⁴⁾	14,4	38	90	116	57
	54	RC102 ¹⁾	14,4	78	121	175	57
	105	RC104	14,4	152	171	276	57
	156	RC106 ¹⁾	14,4	226	248	404	57
	203	RC108	14,4	294	298	501	57
	257	RC1010 ¹⁾	14,4	373	349	606	57
	304	RC1012	14,4	441	400	704	57
	356	RC1014	14,4	516	451	807	57
15 (142)	25	RC151	20,3	51	124	149	70
	51	RC152	20,3	104	149	200	70
	101	RC154 ¹⁾	20,3	205	200	301	70
	152	RC156 ¹⁾	20,3	308	271	423	70
	203	RC158	20,3	411	322	525	70
	254	RC1510	20,3	516	373	627	70
	305	RC1512	20,3	619	424	729	70
	356	RC1514	20,3	723	475	831	70
25 (232)	26	RC251	33,3	86	140	166	86
	50	RC252 ¹⁾	33,3	166	165	215	86
	102	RC254 ¹⁾	33,3	339	216	318	86
	158	RC256 ¹⁾	33,3	525	273	431	86
	210	RC258	33,3	697	324	534	86
	261	RC2510	33,3	867	375	636	86
	311	RC2512	33,3	1033	425	736	86
	362	RC2514 ¹⁾	33,3	1202	476	838	86
30 (295)	209	RC308	42,9	880	387	596	102
50 (498)	51	RC502	71,3	362	176	227	127
	101	RC504	71,3	719	227	328	127
	159	RC506 ¹⁾	71,3	1131	283	442	127
	260	RC5010	71,3	1855	384	644	127
	337	RC5013	71,3	2399	460	797	127
75 (718)	156	RC756	102,6	1601	286	442	146
	333	RC7513	102,6	3417	492	825	146
95 (933)	51	RC1002	133,1	676	219	270	178
	168	RC1006	133,1	2239	357	525	178
	260	RC10010	133,1	3466	449	709	178

¹⁾ Available as set, see note on page 7.

²⁾ RC50 cylinder has a non removable grooved saddle and no collar thread.

³⁾ RC50: D1 = 41 mm, L = 20 mm, M = 25 mm.

⁴⁾ RC101 has plunger with two thread holes and non-removable saddle.

Single-Acting, General Purpose Cylinders

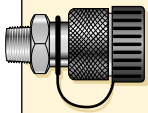

Couplers Included!

CR-400 couplers included on all models. Fits all HC-Series hoses.

Capacity:

5 - 95 ton

Stroke:

16 - 362 mm

Maximum Operating Pressure:

700 bar

RC-Trio Series



Cylinder Bore Dia. E (mm)	Plunger Dia. F (mm)	Base to Adv. Port H (mm)	Saddle Dia. J (mm)	Saddle Protr. from Plgr. K (mm)	Plunger Internal Thread O	Plunger Thread Length P (mm)	Base Mounting Holes			Collar Thread W	Collar Thread Length X (mm)	 (kg)	Model Number
							Bolt Circle U (mm)	Thread V	Thd. Depth Z (mm)				
28,6	25,4	19	2)	2)	2)	2)	29	5,6 mm	—	—	—	1,0	RC50 ²⁾
28,6	25,4	19	25	6	3/4" - 16 UN	14	25	1/4" - 20 UNC	14	1 1/2" - 16 UN	28	1,0	RC51
28,6	25,4	19	25	6	3/4" - 16 UN	14	25	1/4" - 20 UNC	14	1 1/2" - 16 UN	28	1,5	RC53
28,6	25,4	19	25	6	3/4" - 16 UN	14	25	1/4" - 20 UNC	14	1 1/2" - 16 UN	28	1,9	RC55 ¹⁾
28,6	25,4	19	25	6	3/4" - 16 UN	16	25	1/4" - 20 UNC	14	1 1/2" - 16 UN	28	2,4	RC57
28,6	25,4	19	25	6	3/4" - 16 UN	16	25	1/4" - 20 UNC	14	1 1/2" - 16 UN	28	2,8	RC59
42,8	38,1	19	—	—	#10 - 24 UN	6	40	5/16" - 18 UNC	12	2 1/4" - 14 UN	27	1,8	RC101 ⁴⁾
42,8	38,1	19	35	6	1" - 8 UN	19	40	5/16" - 18 UNC	12	2 1/4" - 14 UN	27	2,3	RC102 ¹⁾
42,8	38,1	19	35	6	1" - 8 UN	19	40	5/16" - 18 UNC	12	2 1/4" - 14 UN	27	3,3	RC104
42,8	38,1	19	35	6	1" - 8 UN	19	40	5/16" - 18 UNC	12	2 1/4" - 14 UN	27	4,4	RC106 ¹⁾
42,8	38,1	19	35	6	1" - 8 UN	19	40	5/16" - 18 UNC	12	2 1/4" - 14 UN	27	5,4	RC108
42,8	38,1	19	35	6	1" - 8 UN	19	40	5/16" - 18 UNC	12	2 1/4" - 14 UN	27	6,4	RC1010 ¹⁾
42,8	38,1	19	35	6	1" - 8 UN	19	40	5/16" - 18 UNC	12	2 1/4" - 14 UN	27	6,8	RC1012
42,8	38,1	19	35	6	1" - 8 UN	19	40	5/16" - 18 UNC	12	2 1/4" - 14 UN	27	8,2	RC1014
50,8	41,3	19	38	9	1" - 8 UN	25	48	3/8" - 16 UNC	12	2 3/4" - 16 UN	30	3,3	RC151
50,8	41,3	19	38	9	1" - 8 UN	25	48	3/8" - 16 UNC	12	2 3/4" - 16 UN	30	4,1	RC152
50,8	41,3	19	38	9	1" - 8 UN	25	48	3/8" - 16 UNC	12	2 3/4" - 16 UN	30	5,0	RC154 ¹⁾
50,8	41,3	25	38	9	1" - 8 UN	25	48	3/8" - 16 UNC	12	2 3/4" - 16 UN	30	6,8	RC156 ¹⁾
50,8	41,3	25	38	9	1" - 8 UN	25	48	3/8" - 16 UNC	12	2 3/4" - 16 UN	30	8,2	RC158
50,8	41,3	25	38	9	1" - 8 UN	25	48	3/8" - 16 UNC	12	2 3/4" - 16 UN	30	9,5	RC1510
50,8	41,3	25	38	9	1" - 8 UN	25	48	3/8" - 16 UNC	12	2 3/4" - 16 UN	30	10,9	RC1512
50,8	41,3	25	38	9	1" - 8 UN	25	48	3/8" - 16 UNC	12	2 3/4" - 16 UN	30	11,8	RC1514
65,1	57,2	25	51	10	1 1/2" - 16 UN	25	59	1/2" - 13 UNC	19	3 5/16" - 12 UN	49	5,9	RC251
65,1	57,2	25	51	10	1 1/2" - 16 UN	25	59	1/2" - 13 UNC	19	3 5/16" - 12 UN	49	6,4	RC252 ¹⁾
65,1	57,2	25	51	10	1 1/2" - 16 UN	25	59	1/2" - 13 UNC	19	3 5/16" - 12 UN	49	8,2	RC254 ¹⁾
65,1	57,2	25	51	10	1 1/2" - 16 UN	25	59	1/2" - 13 UNC	19	3 5/16" - 12 UN	49	10,0	RC256 ¹⁾
65,1	57,2	25	51	10	1 1/2" - 16 UN	25	59	1/2" - 13 UNC	19	3 5/16" - 12 UN	49	12,2	RC258
65,1	57,2	25	51	10	1 1/2" - 16 UN	25	59	1/2" - 13 UNC	19	3 5/16" - 12 UN	49	14,1	RC2510
65,1	57,2	25	51	10	1 1/2" - 16 UN	25	59	1/2" - 13 UNC	19	3 5/16" - 12 UN	49	16,3	RC2512
65,1	57,2	25	51	10	1 1/2" - 16 UN	25	59	1/2" - 13 UNC	19	3 5/16" - 12 UN	49	17,7	RC2514 ¹⁾
73,0	57,2	29	51	10	1 1/2" - 16 UN	25	59	1/2" - 13 UNC	16	3 5/16" - 12 UN	49	18,1	RC308
95,2	79,4	33	71	2	—	—	95	1/2" - 13 UNC	19	5" - 12 UN	55	15,0	RC502
95,2	79,4	33	71	2	—	—	95	1/2" - 13 UNC	19	5" - 12 UN	55	19,1	RC504
95,2	79,4	35	71	2	—	—	95	1/2" - 13 UNC	19	5" - 12 UN	55	23,1	RC506 ¹⁾
95,2	79,4	35	71	2	—	—	95	1/2" - 13 UNC	19	5" - 12 UN	55	31,8	RC5010
95,2	79,4	35	71	2	—	—	95	1/2" - 13 UNC	19	5" - 12 UN	55	37,6	RC5013
114,3	95,3	30	71	2	—	—	114	5/8" - 11 UNC	16	5 3/4" - 12 UN	44	29,5	RC756
114,3	95,3	30	71	2	—	—	114	5/8" - 11 UNC	16	5 3/4" - 12 UN	44	59,0	RC7513
130,2	104,8	41	71	2	—	—	140	3/4" - 10 UNC	25	6 7/8" - 12 UN	44	36,7	RC1002
130,2	104,8	41	71	2	—	—	140	3/4" - 10 UNC	25	6 7/8" - 12 UN	44	59,0	RC1006
130,2	104,8	41	71	2	—	—	140	3/4" - 10 UNC	25	6 7/8" - 12 UN	44	72,6	RC10010

SELECTION CHART

For use with Cylinder Capacity ton (kN)	Saddles			Base Plate	Mounting Block	Clevis Eyes	
	Flat	Grooved ¹⁾	Tilt			Base ⁴⁾	Plunger
5 (45)	A53F ²⁾	A53G ²⁾	-	-	RB5 ²⁾ , AW51 ²⁾ , AW53 ²⁾	REB5 ²⁾	REP5 ²⁾
10 (101)	A12 ³⁾ , A102F ³⁾	A102G ³⁾	CATS12 ³⁾	JB110 ³⁾	RB10, AW102	REB10	REP10 ³⁾
15 (142)	-	A152G	CATS12	-	RB15	REB15	REP10
25 (232)	A29 ⁵⁾	A252G	CATS52	JB125	RB25	REB25	REP25
30 (295)	A29 ⁵⁾	A252G	CATS52	-	RB25	-	REP25
50 (498)	-	-	CATS100	JB150	-	-	-
75 (718)	-	-	CATS100	-	-	-	-
95 (933)	-	-	CATS100	-	-	-	-

¹⁾ Standard on 5-30 ton RC-cylinders ²⁾ Except RC50 ³⁾ Except RC101 ⁴⁾ Mounting screws are included. ⁵⁾ Used with Bender Sets.

DIMENSION CHARTS

Model Number	Saddle Dimensions (mm)			A53F, A102F A12, A29	For Cylinder Capacity ton (kN)	Tilt Saddle Model Number	Addition to Collapsed Height A1 (mm)	Saddle Diameter J1 (mm)	
	A	B	C						
Flat					10 (101)	CATS12	14	35	
A53F	25	6	17	15 (142)	CATS12	11	35		
A102F	35	6	22	25 (232)	CATS52	15	50		
A12	51	48	1"-8 UNC	30 (295)	CATS52	15	50		
Grooved					50 (498)	CATS100	15	71	
A53G	25	6	17	75 (718)	CATS100	15	71		
A102G	35	6	22	95 (933)	CATS100	15	71		
A152G	38	9	22						
A252G	50	9	35						

Model Number	Base Plate Dimensions (mm)						
	A	B	C	D	E		
JB110	228	228	135	58	20		
JB125	279	279	140	86	26		
JB150	304	15	95	131	31		

Model Number	Mounting Block Dimensions (mm)											
	A	B	C	D	E	F	G	H				
RB5	1 1/2"-16UN	88	76	-	25	-	-	-				
AW51	1 1/2"-16UN	70	59	10	24	54	1/4"-16 UN	41				
AW53	1 1/2"-16UN	72	7	7	19	57	1/4"-20 UN	10				
RB10	2 1/4"-14UN	114	88	-	25	-	-	-				
AW102	2 1/4"-14UN	100	82	16	30	76	7/16"-20 UN	58				
RB15	2 3/4"-16UN	101	114	-	38	-	-	-				
RB25	3 5/16"-12UN	127	165	-	50	-	-	-				

Type	Model Number	Clevis Eye Dimensions (mm)						Pin-to-Pin* (mm)		
		A	B	C	D	E	F			
Base ⁴⁾	REB5	44	47	14	16	16	25	60,2		
	REB10	63	66	25	22	25	35	78,0		
	REB15	76	66	25	22	25	35	78,0		
	REB25	95	79	38	31	31	41	87,6		
Plunger	REP5	28	45	14	16	16	19	-		
	REP10	42	61	25	22	25	28	-		
	REP25	57	71	38	31	31	35	-		

⁴⁾ Mounting screws are included.

* Pin to Pin – REB and REP Clevises fitted. Add cylinder collapsed height.