

▼ Shown from left to right: RSM-1000, RSM-300, RSM-50, RCS-1002, RCS-302



## Maximum Power-to-Height Ratio



### Saddles

All RCS-Series cylinders have plunger mounting holes for installation of tilt saddles. See table for selection and dimensional information.

Page: **23**



### Low Clearance Lifting

The LW-16 Lifting Wedge and SOH-Series Machine Lifts are the perfect choice for lifting the first few millimeters.

Page: **166**

### RSM-series, Flat-Jac® Cylinders

- Compact, flat design for use where most other cylinders will not fit
- Single-acting, spring return
- RSM-750, 1000 and 1500 have handles for easy carrying
- Mounting holes permit easy fixturing
- Baked enamel finish for increased corrosion resistance
- CR-400 coupler and dust cap included on all models<sup>1)</sup>
- Hard chrome plated high quality steel plungers
- Grooved plunger ends require no saddle.

### RCS-series, Low Height Cylinders

- Lightweight, low profile design for use in confined spaces
- Single-acting, spring return
- Baked enamel finish for increased corrosion resistance
- Plunger wiper reduces contamination, extending cylinder life
- CR-400 coupler and dust cap included on all models
- Grooved plunger end with threaded holes for mounting tilt saddles
- Integral handle on RCS-1002 for easy carrying
- Plated steel plungers.

▼ Only a couple of centimeters will do for an RSM-cylinder to lift a large construction.

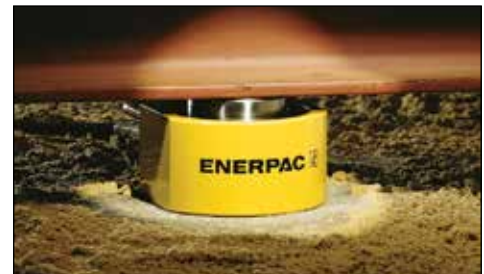

Cyl. Capacity	Stroke	Model Number	Cylinder Effective Area	Oil Capacity
ton (kN)	(mm)		(cm <sup>2</sup> )	(cm <sup>3</sup> )
5 (45)	6	RSM-50 <sup>1)</sup>	6,5	4
10 (101)	11	RSM-100	14,5	18
20 (201)	11	RSM-200	28,7	32
30 (295)	13	RSM-300	42,1	55
45 (435)	16	RSM-500	62,1	99
75 (718)	16	RSM-750	102,6	164
90 (887)	16	RSM-1000	126,7	203
150 (1386)	16	RSM-1500	198,1	317
10 (101)	38	RCS-101*	14,5	55
20 (201)	45	RCS-201*	28,7	129
30 (295)	62	RCS-302*	42,1	261
45 (435)	60	RCS-502*	62,1	373
90 (887)	57	RCS-1002*	126,7	722

<sup>1)</sup> RSM-50 is fitted with an AR-400 coupler.

\* Available as set, see note on next page.

# Single-Acting, Low Height Cylinders

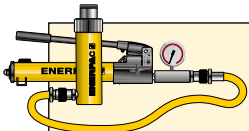

## Cylinder-Pump Sets

All cylinders marked with an \* are available as (cylinder, gauge, couplers, hose and pump) for your ordering convenience.

Page: **58**

## RSM, RCS Series



Capacity:

**5 - 150 ton**

Stroke:

**6 - 62 mm**

Maximum Operating Pressure:

**700 bar**

### Optional Bolt On Tilt Saddle Dimensions (mm)

For Cylinder Model:	Model Number	A	B	C*
RCS-101	CAT-11	35	11	21
RCS-201, -302, -502	CAT-51	50	15	29
RCS-1002	CAT-101	71	17	35

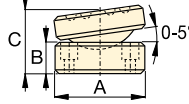

\* 'C' dimension equals saddle protrusion from plunger. Mounting screws are included.

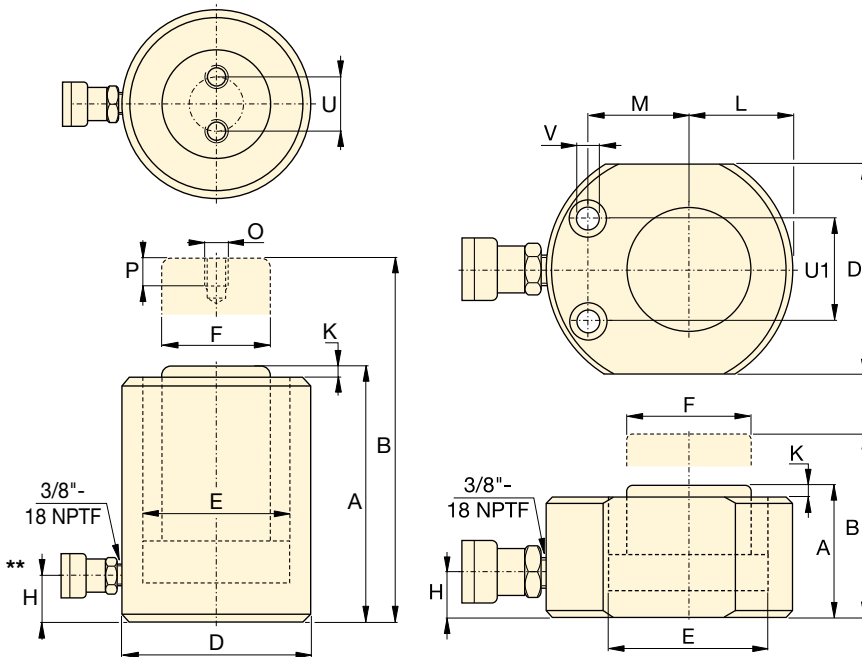

RCS-Series

RSM-Series

### RSM Cylinder Mounting Hole Dimensions (mm)

Model Number	Bolt Circle U1	Hole Dia. V	Counter Bore Dia.	Counter Bore Depth
RSM-50	28,5	5,5	9,1	4,3
RSM-100	36,6	7,1	10,7	7,9
RSM-200	49,3	10,0	15,1	9,9
RSM-300	52,3	10,0	15,9	11,2
RSM-500	66,5	11,0	19,0	12,7
RSM-750	76,2	13,5	20,6	14,2
RSM-1000	76,2	13,5	20,6	14,2
RSM-1500	117,3	13,5	20,6	14,2

Collapsed Height A (mm)	Extended Height B (mm)	Outside Diameter D (mm)	Cylinder Bore Dia. E (mm)	Plunger Dia. F (mm)	Base to Advance Port H (mm)	Plunger Protrusion from Base K (mm)	Plunger to Base L (mm)	Plunger to Mtg. Hole M (mm)	Thread O (mm)	Thread Depth P (mm)	Bolt Circle U (mm)	Weight (kg)	Model Number
32	38	58 x 41	28,7	25,4	16	1	20	22	-	-	-	1,0	RSM-50 <sup>1)</sup>
43	54	82 x 55	42,9	38,1	19	1	27	34	-	-	-	1,4	RSM-100
51	62	101 x 76	60,5	50,8	19	1	39	39	-	-	-	3,1	RSM-200
58	71	117 x 95	73,2	63,4	19	2	47	44	-	-	-	4,5	RSM-300
66	82	140 x 114	88,9	69,8	19	2	57	53	-	-	-	6,8	RSM-500
79	95	165 x 139	114,3	82,6	19	2	69	66	-	-	-	11,3	RSM-750
85	101	178 x 153	127,0	92,2	19	2	76	74	-	-	-	14,5	RSM-1000
100	116	215 x 190	158,8	114,3	23	2	95	82	-	-	-	26,3	RSM-1500
88	126	69	42,9	38,1	17	5	-	-	M4	8	26	2,7	RCS-101*
98	143	92	60,5	50,8	17	3	-	-	M5	8	40	5,0	RCS-201*
117	179	101	73,2	66,5	19	3	-	-	M5	8	40	6,8	RCS-302*
122	182	124	88,9	69,8	23	2	-	-	M5	8	40	10,0	RCS-502*
141	198	165	127,0	92,2	31	1	-	-	M8	10	55	20,7	RCS-1002*

\*\* 5° angle position of coupler on RCS-101, 201, 302.